

# RAIDON

## iU2300-U6P3 快速安裝導引

### 產品示意圖與配件表

iU2300前視圖



iU2300背視圖

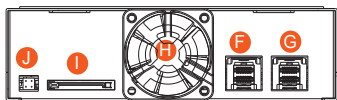

- A LED 指示燈
- B 硬碟抽取盒鎖及頂出按鍵
- C 硬碟抽取盒把手
- D RELEASE 按鍵1(HDD1)
- E RELEASE 按鍵2(HDD2)
- F PCIE(SAS 1 連接埠)(HDD1)
- G PCIE(SAS 2 連接埠)(HDD2)
- H 風扇
- I SATA 15Pin 電源輸入埠
- J Hot plug Switch 連接埠

**NOTE** 如搭配銳銜科技的 PC05-U6P3 ( PCIe Card ) & PC05-U6P3P-I ( PCIe Card ) 則無需使用

打開包裝外盒後,包裝內容應包含下列組件:

產品本體	螺絲及鑰匙
快速安裝導引	

- SAS Cable & PCIE Card 不附在配件上,如有需求請另外選配購買。
- 請先確認相關配件與產品本身是否有受損或是缺少配件,若有任何疑問,請與您的經銷商或業務人員聯絡。
- 請前往官網 ([www.raidon.com.tw](http://www.raidon.com.tw)) 下載說明書、驅動程式以及其餘相關資源。



V0.2(Feb. 2024)

1

### 燈號說明

狀態	硬碟燈號
硬碟閒置	紫燈恆亮 (註 1)
資料存取	紫燈閃爍 (註 2)
無SSD	紫燈恆亮

- 註 1: 依據使用的SSD會有不同的燈號狀態。  
 註 2: 如SSD有支援,資料存取時LED有閃爍功能;如無支援,則無閃爍功能。

### 硬體安裝

請參照下列步驟,完成 iU2300 的硬體安裝:

- 將主體裝置在機殼上,連接相關連接線,並確認固定螺絲是否鎖上。

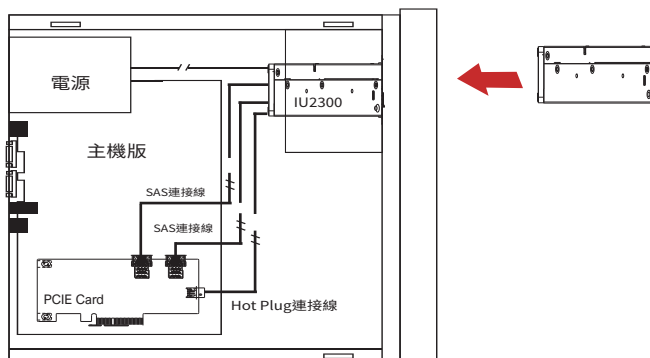

內接主機殼示意圖

2

### ※ 螺絲孔位說明

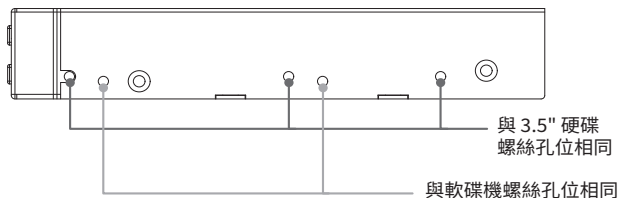

- 請使用零件包內附的鑰匙開鎖,頂出按鍵向右推移,硬碟抽取盒把手便會彈開,即可取出。

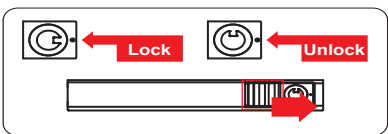

- 抽出M.2 托盤組,取上上蓋的2顆螺絲。

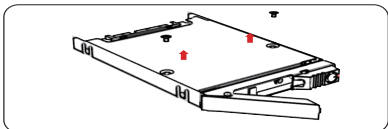

- 打開上蓋,取出螺絲。

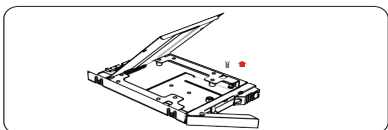

- 插入 M.2 NVMe SSD 並鎖上螺絲。

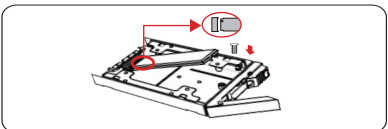

3

- 蓋回上蓋。
- 鎖上螺絲。
- 安裝完成後請將抽取盒平移放入主機內並關上把手。

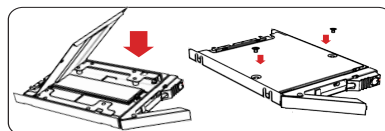

- 安裝完成。開啟電源後請透過作業系統進行後續格式化設定,完成硬碟格式化後,便可以進行資料的讀寫。

### 產品使用注意事項

- 強烈建議除了使用iU2300 的資料儲存功能外,請針對重要資料備份到另一個儲存裝置上或遠端備份, 雙重備份您重要的資料。若您儲存在iU2300 的資料損毀或遺失,RAIDON 將不負任何的責任。

感謝您使用 銳銜科技股份有限公司 的產品。

本手冊裡的資訊在出版前雖然已經被詳細確認,但實際產品規格將已出貨時為準;任何的產品規格或相關資訊更新,請您直接上 [www.RAIDON.com.tw](http://www.RAIDON.com.tw) 網站查詢,或直接與您的業務聯絡窗口聯繫,本公司將不另行通知。

如果您對銳銜科技的產品有任何疑問,或是想獲得最新產品訊息、使用手冊或韌體,請您聯絡[supporting@raidon.com.tw](mailto:supporting@raidon.com.tw),我們將儘速回覆您。

RAIDON 為 銳銜科技股份有限公司 旗下品牌之一  
 本說明相關產品內容歸 銳銜科技股份有限公司 版權所有

4

# RAIDON

## iU2300-U6P3 Quick Installation Guide

### Product Diagrams and Contents of Product Package

Front View



- A** LED Indicator
- B** Removable drive tray
- C** HDD Tray Key Lock & Tray Ejection
- D** RELEASE Button1(HDD1)
- E** RELEASE Button2(HDD2)

Rear View



- F** PCIE(SAS 1 Connector)(HDD1)
- G** PCIE(SAS 2 Connector)(HDD2)
- H** FAN
- I** 15 Pin Power Connector
- J** Hot plug Switch Connector

**NOTE** **D E J** If you use PC05-U6P3 (PCIe Card) & PC05-U6P3P-I (PCIe Card) with Raidon Technology, you do not need to use it.

Open the package and you should find the following:

Product x 1	
Quick Installation Guide x1	Screws & Key

- SAS Cable & PCIe Card is not attached to the accessories, if you need it, please purchase it separately.
- Please check the product and accessories for any defect or missing parts. If you have any questions, please contact your product supplier.
- Please visit the official website ([www.raidon.com.tw](http://www.raidon.com.tw)) to download user manuals, drivers and other related resources.



V0.2(Feb. 2024)

1

### LED Instruction

Status	HDD Status Light
HDD idle	Purple light always On (Note 1)
Data access	Purple light flashing (Note 2)
No SSD	Purple light always On

Note1: While using a different SSD Hard Drives, the LED Indication might be with a different light set.

Note2: If the SSD is supported, the LED has a flashing function during data access; if there is no support, there is no flashing function.

### Hardware Installation

Please install iU2300 as the following instruction.

1. Install the product unit into the computer chassis and make the necessary connections and mount the product unit properly and securely to the bay position desired.

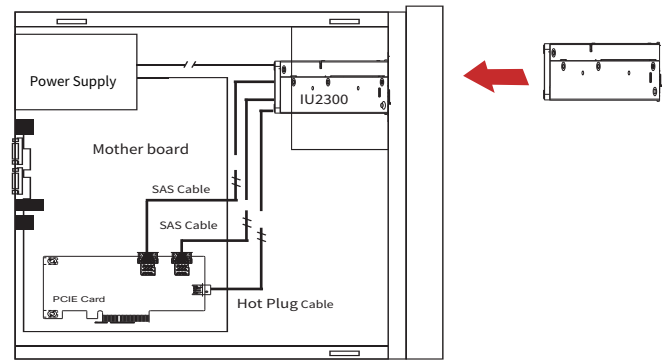

Internal Case

2

### Mounting Positions

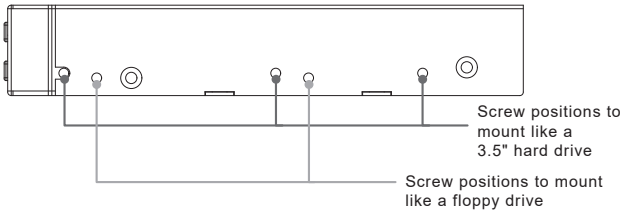

2. Unlock the Tray Key Lock and push the HDD tray ejection to the right.

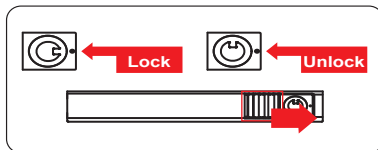

3. Remove the screws of the upper cover of the M.2 Tray.

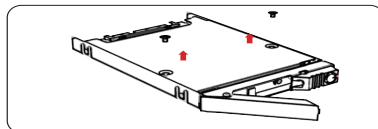

4. Open the upper cover and remove the screw.

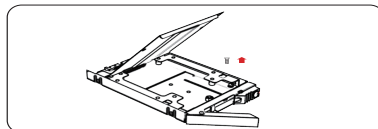

5. Insert M.2 NVMe SSD and fix the screw.

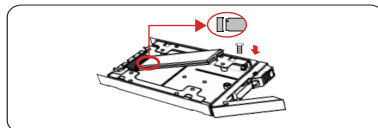

3

6. Put the upper cover back.
7. Fix the screws.
8. Install the M.2 tray back into the iU2300.

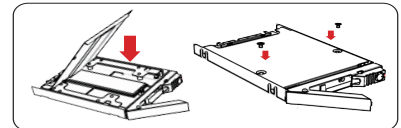

9. Power on your system after hardware installation is completed, and your operating system will automatically detect the hard drives from booting. Then follow the steps from your operating system to partition and format the drives when necessary, device will be ready to use once the format is completed.

### Precautions Before Application

1. We strongly recommend you to keep an extra copy at your important personal data other than stored in your iU2300 product. RAIDON will not be responsible of your data loss problem.

Thank you for choosing RAIDON's product.

The information provided in this manual was checked before publication, but the actual product specifications may have changed before shipping; Latest product specifications and updates can be found at [www.RAIDON.com.tw](http://www.RAIDON.com.tw) or through your sales representative. No separate notifications will be provided by our company.

If you have any questions about RAIDON products or would like to receive the latest product information, instruction manuals, or firmware, please contact [Supporting@raidon.com.tw](mailto:Supporting@raidon.com.tw) for assistance.

RAIDON is one brand under RAIDON TECHNOLOGY, INC.  
All product-related content in this manual are copyrighted by RAIDON TECHNOLOGY, INC.

4